



### Hakkımızda

INOVAMED kurucumuz Mehmet HAFIZOĞLU tarafından , on yedi yıllık başarılı implant üretim tecrübesi ile 2013 yılında kurulmuş olup Türkiye'nin önde gelen üreticilerinden biri olarak, sektörde yer almaktadır.

Geniş ürün yelpazesi, kaliteli hizmet anlayışı ve yenilikçi yaklaşımları ile sektöre en iyi çözümleri sunmak için çalışmalarına devam etmektedir. Günümüzdeki gelişen teknolojik gelişmeleri takip ederek, yeni teknolojik makine, ekipman ve kalite kontrol sistemlerini kullanarak, üretim ve AR-GE çalışmalarını sürdürmektedir.

Temel amacımız; yüksek kalitede başarılı, güvenli ve kullanımı kolay implant üretmektir.

### About us

*INOVAMED was founded in 2013 by our founder Mehmet HAFIZOĞLU, with seventeen years of successful implant production experience, and is one of the leading manufacturing companies in Turkey.*

*It continues to offer good solutions to the sector with its wide product range, quality service approach and comprehensive solutions.*

*We develop production and R&D activities by following today's technological developments and using new technological machines, equipment and quality control systems.*

*Our main aim is; It is the production of quality, successful, safe and easy-to-use implants.*



# İÇİNDEKİLER

About Us	Page 2
Hadron Implant	Page 4
Implant Fixture Line Up	Page 5
Hadron Implant System	Page 6
Implant & Abutment Spec	Page 7
Prosthetic Diagrams For Cemented Restoration	Page 8
Healing Abutments	Page 9
Straight Abutments	Page 10
Angled Abutments	Page 11-12
Lab Components	Page 13
T-base Abutment & Other Solutions	Page 14
Locator System	Page 15
Multi Unit System	Page 16-19
Scan Body	Page 20
One Piece Implant	Page 21-22

## HADRON Implant

The first one millimeter of the implant neck is designed narrower than the implant body diameter that helps to decrease the possible stress formation between implant-bone contact surface around the neck region.

With the special design of the micro threads in the neck and its increased surface area, it allows the peri-implant tissues to be attached to the neck area at the maximum level in the early period. In the long term, it prevents marginal bone loss.

With the double helix thread structure which provides maximum primary stability. This particular morphology, due to the combination of its spiral double threads, provides a greater surface area between the bone and the implant, which accelerates the process of osteointegration.

Within the double helix structure, the outer wide thread design increases the primary stability and reduces the stress that will occur on the bone, the inner narrow threads allow for the reduction of the stress caused by compression and additional surface increase.

The aggressive helical thread structure increases primary stability by preparing its own thread slot at the apex of the implant.

With the surgical set suitable for the conical body structure of the implant, ideal cooling is provided during the surgical application and bone necrosis is prevented.

The 11° conical connection between the implant and abutment creates cold fission, increasing mechanical resistance.

In SLA surface treatment, an ideal surface has been obtained by applying sandblasting and a special acid process. Thus, microcracks and possible corrosion do not occur on the implant surface, and optimal microscopic depth and width are obtained in titanium, which will increase cell adhesion.

As a result of all these processes, HYDROPHILIC surface is formed.

## HADRON Implant

*Boyun kenarının ilk bir milimetresi implant gövde çapından daha dar dizayn edilmiştir. Böylelikle alveolar kret ve tepe noktasını ile implant en tepe noktasından başlayacak olası implant kemik arası stres minimal seviyeye indirilmiştir.*

*Boyun kısmında yer alan mikro yivlerin özel dizaynı ve artırılmış yüzey alanı ile peri implant dokularının erken dönemde maksimum seviyede boyun bölgesine bağlanmayı sağlar. Uzun dönemde ise marjinal kemik kaybını önler.*

*Çift sarmallı yiv yapısı ile maksimum primer stabiliteyi sağlar. Bu özel morfoloji, spiral çift yivlerinin kombinasyonundan dolayı kemik ve implant arasında osteointegrasyon sürecini hızlandıran daha büyük bir yüzey alanı sağlar.*

*Çift sarmal yapıda yer alan dış geniş yiv tasarımı primer stabiliteyi artırır ve kemikte oluşacak stresi azaltır, iç dar yivler ise kompresyon ile oluşan stresin azaltılmasında ve ilave yüzey artırımına olanak sağlar.*

*İmplantın apeksi, agresif yiv yapısı ile kendi yiv yuvasını hazırlayarak, primer stabiliteyi artırır.*

*İmplantın konik gövde yapısına uygun cerrahi set ile , cerrahi uygulama esnasında ideal soğutma sağlanarak kemik nekrozu engellenir.*

*İmplant ve dayanak arasındaki 11° konik bağlantı, soğuk fizyon oluşturarak mekanik direnci artırır.*

*SLA yüzey işleminde, kumlama ve özel asit prosesi uygulanarak ideal yüzey elde edilmiştir. Böylelikle implant yüzeyinde mikro çatlaklar ve olası korozyon oluşmaz, ayrıca titanyumda hücre adezyonunu arttıracak optimal mikroskobik derinlik ve genişlik elde edilir.*

*Tüm bu prosesler sonucunda HİDROFİLİK yüzey oluşur.*



ØDiameter

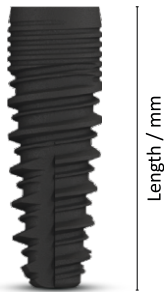

Fixture Diameter	Length
Ø3.4	8 mm
	10 mm
	11.5 mm
	13 mm
	15 mm

ØDiameter

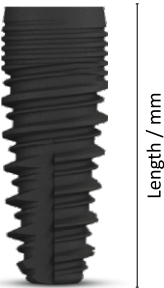

Fixture Diameter	Length
Ø3.7	8 mm
	10 mm
	11.5 mm
	13 mm
	15 mm

ØDiameter

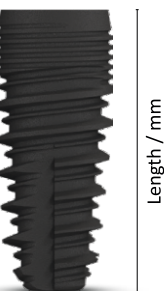

Fixture Diameter	Length
Ø4.1	6 mm
	8 mm
	10 mm
	11.5 mm
	13 mm
	15 mm

ØDiameter

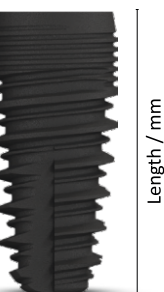

Fixture Diameter	Length
Ø4.8	6 mm
	8 mm
	10 mm
	11.5 mm
	13 mm
	15 mm

- \* Implant Recommended Torque : 35Ncm
- \* Fixture + Cover Screw
- \* Cover Screw Recommended Torque: 10 Ncm

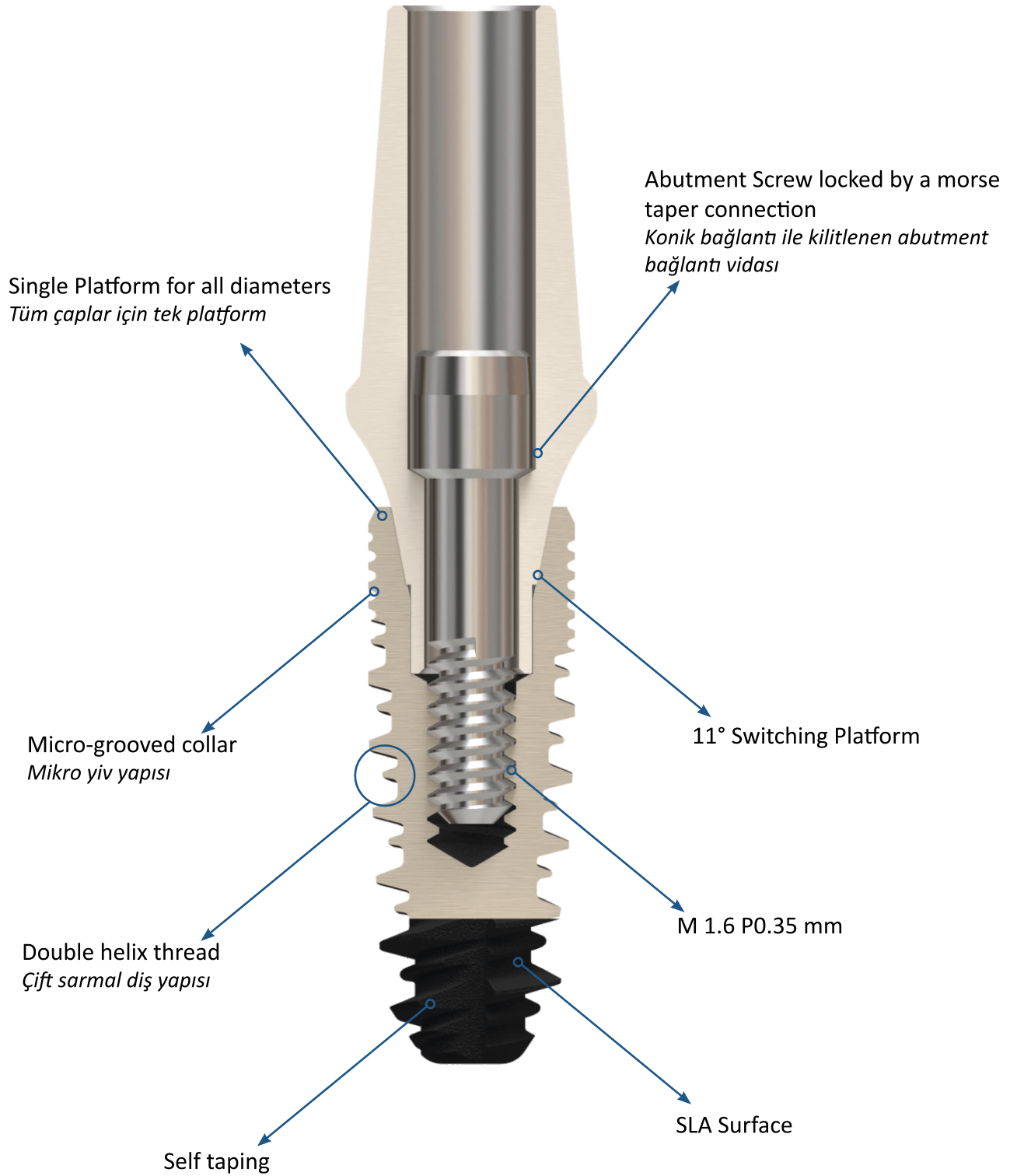

The 11° conical connection between the implant and abutment creates cold fission, increasing mechanical resistance.

*İmplant ve dayanak arasındaki 11° konik bağlantı, soğuk fizyon oluşturarak mekanik direnci artırır.*

Implant and abutments have 2.1 mm hexagon  
*İmplant ve dayanaklar 2.1 mm hexagonal yapıya sahiptir.*

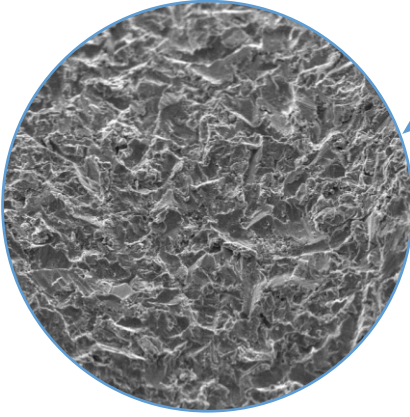

In SLA surface treatment, an ideal surface has been obtained by applying sandblasting and a special acid process. Thus, microcracks and possible corrosion do not occur on the implant surface, and optimal microscopic depth and width are obtained in titanium, which will increase cell adhesion.

*SLA, Yüzey işleminde, kumlama ve özel asit prosesi uygulanarak ideal yüzey elde edilmiştir. Böylelikle implant yüzeyinde mikro çatlaklar ve olası korozyon oluşmaz, ayrıca titanyumda hücre adezyonunu arttıracak optimal mikroskobik derinlik ve genişlik elde edilir.*



SINUS COVER SCREW



COVER SCREW



ABUTMENT SCREW

M 1.6 / P0.35 mm  
HEX 1.25 mm

Impression Coping



Lab Analog



Abutment Screw



Abutment

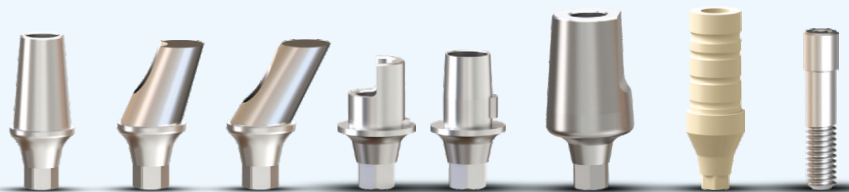

Healing



Implant Fixture





Abutment Diameter	G/H	REF No
Ø4.0	1 mm	HH4010
	2 mm	HH4020
	3 mm	HH4030
	4 mm	HH4040
	5 mm	HH4050

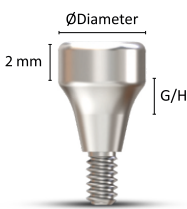

Abutment Diameter	G/H	REF No
Ø4.5	1 mm	HH4510
	2 mm	HH4520
	3 mm	HH4530
	4 mm	HH4540
	5 mm	HH4550

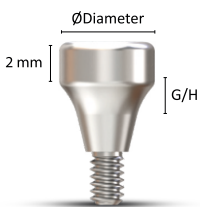

Abutment Diameter	G/H	REF No
Ø5.5	1 mm	HH5510
	2 mm	HH5520
	3 mm	HH5530
	4 mm	HH5540
	5 mm	HH5550

\* Recommended torque : 20Ncm



Abutment Diameter	G/H	REF No
Ø4.0	1 mm	HAS4010H
	2 mm	HAS4020H
	3 mm	HAS4030H
	4 mm	HAS4040H
	5 mm	HAS4050H



Abutment Diameter	G/H	REF No
Ø4.5	1 mm	HAS4510H
	2 mm	HAS4520H
	3 mm	HAS4530H
	4 mm	HAS4540H
	5 mm	HAS4550H



Abutment Diameter	G/H	REF No
Ø5.5	1 mm	HAS5510H
	2 mm	HAS5520H
	3 mm	HAS5530H
	4 mm	HAS5540H
	5 mm	HAS5550H

15° ANGLED ABUTMENT



15° Angled Abutment

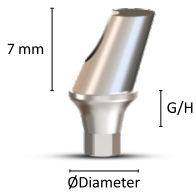

Abutment Diameter	G/H	REF No
Ø4.0	1 mm	HAA154010H
	2 mm	HAA154020H
	3 mm	HAA154030H
	4 mm	HAA154040H
	5 mm	HAA154050H

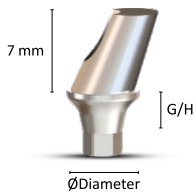

Abutment Diameter	G/H	REF No
Ø4.5	1 mm	HAA154510H
	2 mm	HAA154520H
	3 mm	HAA154530H
	4 mm	HAA154540H
	5 mm	HAA154550H

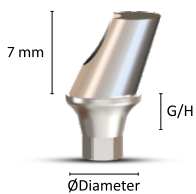

Abutment Diameter	G/H	REF No
Ø5.5	1 mm	HAA155510H
	2 mm	HAA155520H
	3 mm	HAA155530H
	4 mm	HAA155540H
	5 mm	HAA155550H

\* Recommended torque : 20Ncm  
\* Connecting screw included

## 25° ANGLED ABUTMENT



### 25° Angled Abutment

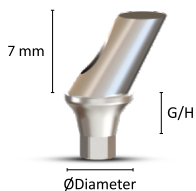

Abutment Diameter	G/H	REF No
Ø4.0	1 mm	HAA254010H
	2 mm	HAA254020H
	3 mm	HAA254030H
	4 mm	HAA254040H
	5 mm	HAA254050H

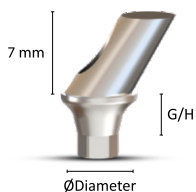

Abutment Diameter	G/H	REF No
Ø4.5	1 mm	HAA254510H
	2 mm	HAA254520H
	3 mm	HAA254530H
	4 mm	HAA254540H
	5 mm	HAA254550H



Abutment Diameter	G/H	REF No
Ø5.5	1 mm	HAA255510H
	2 mm	HAA255520H
	3 mm	HAA255530H
	4 mm	HAA255540H
	5 mm	HAA255550H

\* Recommended torque : 20Ncm  
 \* Connecting screw included



Abutment Diamater	G/H	REF No
Ø3.4	11 mm	HLA34
Ø4.0	11 mm	HLA40
Ø4.5	11 mm	HLA45



Abutment Diamater	G/H	REF No
Ø4.0	13 mm	HIO40SH
Ø4.5	13 mm	HIO45SH
Ø4.0	16 mm	HIO40LH
Ø4.5	16 mm	HIO45LH

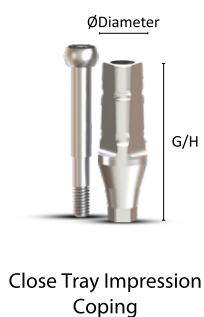

Abutment Diamater	G/H	REF No
Ø4.0	13 mm	HIC40SH
Ø4.5	13 mm	HIC45SH
Ø4.0	16 mm	HIC40LH
Ø4.5	16 mm	HIC45LH

T-BASE Abutment



Abutment Diameter	G/H	REF No
Ø4.5	1 mm	HATB10N
	2 mm	HATB20N
	3 mm	HATB30N
	4 mm	HATB40N

T-BASE Angled Abutment



Abutment Diameter	G/H	REF No
Ø4.5	1 mm	HATBA10N
	2 mm	HATBA20N
	3 mm	HATBA30N
	4 mm	HATBA40N

Milling Abutment



Abutment Diameter	G/H	REF No
Ø7.0	1 mm	HMA

Ucla Abutment



Abutment Diameter	G/H	REF No
Ø4.5	1 mm	HATBA10N

Temporary Abutment Peek / Titanium



Abutment Diameter	Type	REF No
Ø4.5	Titanium	HATS45T0H
Ø5.5	Titanium	HATS55T0H
Ø4.5	Peek	HATS45P0H
Ø5.5	Peek	HATS55P0H

\* Recommended torque : 10Ncm  
 \* Connecting screw included

Locator System



Abutment Diameter	G/H	REF No
Ø4.0	1 mm	HLA4510
	2 mm	HLA4520
	3 mm	HLA4530
	4 mm	HLA4540
	5 mm	HLA4550

\* Recommended torque : 20Ncm



Locator Lab Analog

REF No
HLA

\* Recommended torque : 20Ncm



METAL HOUSING  
REF:HLTC



SLICONS  
SOFT



SLICONS  
NORMAL



SLICONS  
HARD



Impression Coping

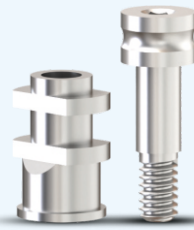

Lab Analog



Abutment Screw  
Retaining Screw



Abutment



Healing



Implant Fixture





Multi Straight Abutment



Abutment Diameter	G/H	REF No
Ø5.0	1 mm	HAMUS10
	2 mm	HAMUS20
	3 mm	HAMUS30
	4 mm	HAMUS40

\* Recommended torque : 20Ncm

Multi 17° Angled Abutment



Abutment Diameter	G/H	REF No
Ø5.0	2 mm	HAMUA1720
	4 mm	HAMUA1740

\* Recommended torque : 20Ncm

\* Connecting screw included

Multi 30° Angled Abutment



Abutment Diameter	G/H	REF No
Ø5.0	2 mm	HAMUA2520
	4 mm	HAMUA2520

\* Recommended torque : 20Ncm

\* Connecting screw included

Multi T-Base Abutment

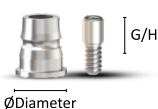

REF No
HMUTB

\* Recommended torque : 10Ncm

\* Retaining screw included

## Multi Unit System

Multi Temporary Abutment



ØDiameter

Abutment Diamater	Type	REF No
Ø5.0	Titanium	HMUTAT

\* Recommended torque : 10Ncm  
\* Retaining screw included

Multi Temporary Abutment

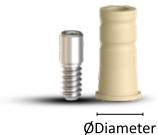

ØDiameter

Abutment Diamater	Type	REF No
Ø5.0	Peek	HMUTAP

\* Recommended torque : 10Ncm  
\* Retaining screw included

Multi Temporary Abutment



ØDiameter

Abutment Diamater	Type	REF No
Ø5.0	Plastic	HMUTAP

\* Recommended torque : 10Ncm  
\* Retaining screw included

Multi Unit Healing



REF No
HMUHA

\* Recommended torque : 10Ncm  
\* Retaining screw included

Multi Unit Impression Copings



REF No
HMUICO

\* Recommended torque : 10Ncm  
\* Retaining screw included

Multi Unit Lab Analog



REF No
HMULA

**Scan Body** Recommended torque : 10Ncm

T-Base  
Scan Body



REF No
HMA

Implant  
Scan Body



REF No
HDAS

Digital Implant  
Analog



REF No
HDIA

Digital M.U.  
Scan Body



REF No
HMUSB

Digital M.U.  
Analog



REF No
HMUDA

## HADRON ONE Piece Implant

- **One piece implant, It is suitable for quick, safe and minimally invasive insertion.**
- Tek parça implant, hızlı, güvenli ve minimal invaziv cerrahi için uygundur.
- **The aggressive helical thread structure increases primary stability by preparing its own thread slot at the apex of the implant.**
- İmplantın apeksi, agresif yiv yapısı ile kendi yiv yuvasını hazırlayarak, primer stabiliteyi artırır.
- **Self-tapping screw tip.**
- Kendinden yiv açan.
- **SLA surface treatment creates the best conditions for rapid and complete osteointegration.**
- SLA yüzey işlemi ile hızlı ve tam osteointegrasyon için en iyi koşullar oluşur.
- **Monoblock, no bacterial leakage within the system.**
- Monoblok, sistem içinde bakteri sızıntısı olmaz.

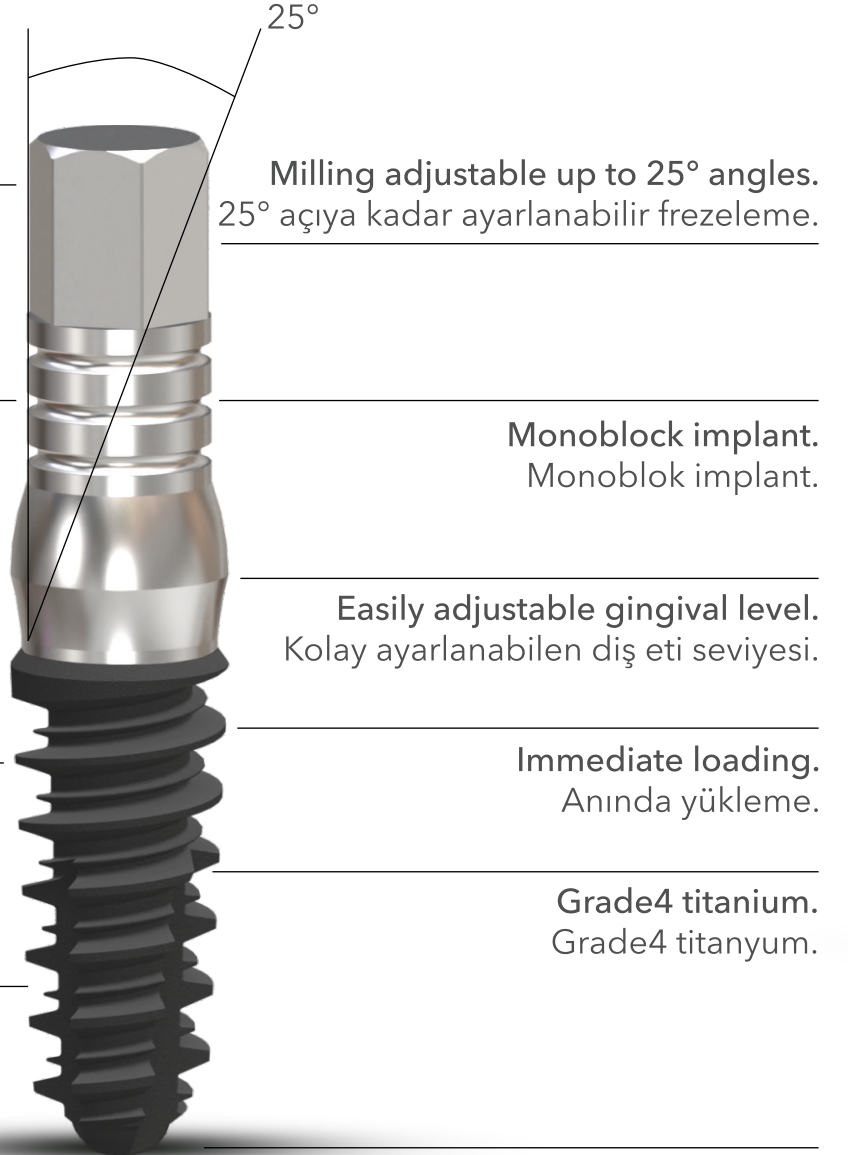

Hexagonal head, for connecting the implant driver.  
İmplant sürücüsünü bağlamak için altıgen başlık.

Excellent resistance to angled loads.  
Açılı yüklere karşı mükemmel direnç.

Double helix groove structure for strong primer stabilization.  
Güçlü primer stabilizasyonu için çift sarmal yiv yapısı

SLA surface treatment.  
SLA Yüzey.

25°  
Milling adjustable up to 25° angles.  
25° açığa kadar ayarlanabilir frezeleme.

Monoblock implant.  
Monoblok implant.

Easily adjustable gingival level.  
Kolay ayarlanabilen diş eti seviyesi.

Immediate loading.  
Anında yükleme.

Grade4 titanium.  
Grade4 titanyum.

Self-tapping apex and rounded tip.  
Kendinden klavuzlu apekse giden yuvarlak uç.



\* Recommended torque : 45Ncm

Fixture Diameter		Length
Ø3.0		8 mm
		10 mm
		11.5 mm
		13 mm
		15 mm

Fixture Diameter		Length
Ø3.4		8 mm
		10 mm
		11.5 mm
		13 mm
		15 mm

Fixture Diameter		Length
Ø4.0		8 mm
		10 mm
		11.5 mm
		13 mm
		15 mm

Fixture Diameter		Length
Ø4.5		8 mm
		10 mm
		11.5 mm
		13 mm
		15 mm

Fixture Diameter		Length
Ø5.0		8 mm
		10 mm
		11.5 mm
		13 mm
		15 mm

# NOTLAR

● .....

● .....

● .....

● .....

● .....

● .....

● .....

● .....

● .....

● .....

● .....



İstanbul Trakya Free Zone Ferhatpaşa SB Mah.  
Gonca Sokak No:4-Z13 Çatalca-İstanbul / Türkiye  
Tel:+90 212 786 61 89 e-mail: info@inovamed.com.tr  
www.inovamed.com.tr

